

# SUPPLIER INSTRUCTIONS FOR USE 2019



BALCONIES · BEAMS · COLUMNS  
FACADES · FLOOR SLABS · FOUNDATIONS  
PREFAB BATHROOMS · ROOF PANELS · SHAFT ELEMENTS  
STAIRS · TRIBUNE ELEMENTS · WALL ELEMENTS

**BETONELEMENT**  
en-oid of CRH Concrete

**DALTON**  
en-oid of CRH Concrete

**EXPAN**  
en-oid of CRH Concrete

**MONTAGE**  
en-oid of CRH Concrete

**MODULBAD**  
en-oid of CRH Concrete

**INDUSTRI**  
en-oid of CRH Concrete

# INTRODUCTION

This supplier Instructions for use has been prepared based on the guideline of the Danish Work Environment Authority, "Supplier's instructions for use for prefabricated construction elements and parts", WEA guideline A.2.3.

Together with the current industry guideline, "Installation of concrete elements and lightweight concrete elements" (Industry guideline) of the Danish building industry association (BAR Bygge og Anlæg) this applies to concrete and lightweight concrete elements and prefab bathrooms supplied by: CRH Concrete A/S · Vestergade 25, Dåstrup · 4130 Viby Sjælland



## AT OUR PRODUCTION SITES

1. Lærkevej 7, 6705 Esbjerg Ø
2. Borumvej 30, 8381 Tilst
3. Karlbyvej 2, Karlby, 9500 Hobro
4. Vestergade 25, Dåstrup, 4130 Viby Sjælland
5. Fredensvej 36, Benløse, 4100 Ringsted
6. Stålværksvej 10, 6800 Varde
7. Ribevej 45, 6650 Brørup
8. Purhusvej 20, Linå, 8600 Silkeborg
9. Snavevej 23, 5471 Søndersø
10. Bækgårdsvej 74, 4140 Borup

This supplier Instructions for use is a supplement to the Industry Guideline and only states that which is not covered by the Industry Guideline. However, important precautions may be specified or repeated in these instructions.

# TABLE OF CONTENT

1. Reference table for WEA guideline A.2.3	4
2. Element data	5
3. Embedded lifting anchors	6
4. General information about the elements	7
5. Specific information about the elements	9
5.1 Columns	9
5.2 Beams	9
5.2.1 Special elements	
5.3 Walls and facades	10
5.3.1 Asymmetrical elements with large openings	
5.3.2 Tilting elements	
5.3.3 Out-of-plumb elements	
5.3.4 Elements with window console	
5.4 Floor slabs	15
5.4.1 Pre-stressed hollow core slabs	
5.4.2 Acoustic floor slabs	
5.4.3 Rib panels and parking slabs	
5.5 Roof panels and waffle slabs	16
5.5.1 Rib panels	
5.5.2 Waffle slabs	
5.6 Balconies, balcony gangways and stairs	18
5.7 Shaft elements	21
5.8 Tribune elements	22
5.9 Foundations	22
5.10 Prefab bathrooms	24
Notes	

# 1. REFERENCE TABLE FOR WEA GUIDELINE A.2.3

Content of Supplier Instructions for use acc. to WEA guideline A.2.3.	Element drawing	Numbered plan	Label or Delivery note	Supplier instructions for use	Industry guidelines
Product name and type	x		x	x	
Production site			x		
Element weight and geometry	x		x		
Transport requirements <sup>2)</sup>					
Information on point of hoisting or attachment of sling	x				
Requirements relating to the use of special lifting equipment				x	
Requirements for any intermediate storage on construction sites				x	x
Special support		x		x	
Location in construction		x			
Training requirements <sup>1)</sup>					x
Whether the construction component constitutes a hazard prior to final integration		x		x	
Weather-related precautions					x
Requirements for the use of personal protection equipment					x

Table 1: Reference for WEA guideline A.2.

1) The installation contractor must have the necessary skills and the fitters must be fully familiar with the contents of the Industry Guideline "Installation of concrete elements and lightweight concrete elements" as well as any associated fact sheets and this Supplier instructions for use.

2) It is assumed that delivery is **not** Ex-Factory. Transport requirements are set out in the BAR fact sheets and CRH Concrete's requirements for carriers and are not included in this supplier's instructions for use. Refer to CRH Concrete's requirements for carriers: Check list of CRH Concrete's safety requirements – when loading, lashing and transporting CRH Concrete products.

Download it from <http://www.crhconcrete.dk/aftalevilkaar-afkald-af-elementer/>

Or scan the QR code:



## 2. ELEMENT DATA

Brand	Location	CE-marking	Factory name or logo	Order No	Element No	Date of casting	Element weight
BETONELEMENT	Esbjerg, Varde, Hobro, Viby og, Ringsted	M	M	M	M	M	M
DALTON	Tilst	M	M	M	M	M	M
EXPAN	Brørup, Linå, Søndersø og Borup	M	M	M	M	M	M
MODULBAD	Ringsted	N/A*					
INDUSTRI	Esbjerg	M	M	M	M	M	M

Table 2: Element data. M = on label, F = on delivery note

\*) Where required, the input elements are CE-marked products of other brands.

Scope of certification, certificates, EC Declarations of Conformity and declared values are stated on the website <https://crhconcrete.dk/aftalevilkaar/produktcertificering/> or scan the QR code below:



### 3. EMBEDDED LIFTING ANCHORS

Embedded anchors	Attach using	Columns	Beams	Walls	Basement sandwich	Hollow core slab	Acoustic floor slabs	Parking slab	Roof elements	Balconies	Stairs	Foundations	Shaft elements	Prefab bathrooms	Tribune elements
Round bar icon lifting eyes	Crane hook	x	x	x	x	x	x								
Wire strap	Crane hook		x	x					x						
Inserts with metric thread	Alpha and wire	x	x	x						x	x		x		
Inserts with metric thread	JDT TP swivel lift														x
Inserts with metric thread <sup>3)</sup>	Schroeder, Wire-list 42, Alpha-list 41 or Goliath-list 40									x	x				
Lifting inserts with knuckle thread	Wire lift etc.							x							
Lifting anchors DEHA	DEHA					x									
Lifting anchors Frimeda <sup>4)</sup>	Frimeda ring-coupling	x	x	x	x <sup>5)</sup>					x	x	x			
AMTE, AMT with stud bolt	Elephant's foot (distancer)	x	x	x									x		
Inserts, eye bolt <sup>2)</sup>	Lifting yoke <sup>2)</sup>													x	
Lifting holes <sup>1)</sup>	Mandrel <sup>1)</sup>	x	x	x								x			x
Waffle slabs	See section 5.5								x						

Table 3: Schedule of used lifting fittings

1) The lifting mandrel must fit the lifting hole in the element and be appropriate for the element weight. The lifting hole diameter is indicated on the element diagram. The Danish association Betonelement-Foreningen and the crane manufacturers have developed a standard "standard" for mandrel sizes and a description that describes the correct use of mandrels. See the Industry guidelines

2) Eye bolts and lifting yokes may be borrowed from CRH Concrete A/S (MODULBAD), see the section on prefab bathrooms under Elements, specifically – section 5.10 Prefab bathrooms.

3) Hoisting in the sides of the edges. Fittings may be borrowed from CRH Concrete A/S (DALTON), see section 5.6

4) When hoisting elements with skirting, the Frimeda ring-coupling with wire loop is prescribed.

5) Used in tilting elements.

## 4. GENERAL INFORMATION ABOUT THE ELEMENTS

### DELIVERY

Columns, short beams, hollow core slab elements, acoustic floor slabs, short joist floors, waffle slabs, balconies, balcony gangways, stairs, shaft and tribune elements are delivered laying on flatbed lorries (general, lowered or special construction).

Walls and facades are delivered standing on frame beds or "innenlader" (flats). Long beams, ribbed slabs and roof elements are delivered on special low-loaders.

### TEMPORARY STORAGE

Unless otherwise indicated, for stacked elements, place chocks underneath and between elements at the same distance from the ends of elements as the embedded anchors. The elements of each stack must be of identical length and the chocks must be placed accurately vertically above each other.

Chock up slab elements, and similar, at three points P (instead of four points), if there is any risk that the base may shift. For elements which have been reloaded from flats, please consult fact sheet from [www.bar-ba.dk](http://www.bar-ba.dk).

### HOISTING

It applies to all types of elements that hoisting must only be undertaken using the embedded lifting anchors.

The unloading of columns, short beams, balconies, stairs, shaft elements, etc. for temporary storage or onto the terrain before they are swivelled into final position in the building, may be carried out using round slings/lifting straps. When using round slings/lifting straps, adhere to the instructions for use provided by the manufacturer of the round slings/lifting straps in detail, to include the protection of element edges. Pay particular attention to the protection of string coves, etc.

Use the lifting equipment carefully and in accordance with the instructions for use provided by the manufacturer of this lifting equipment.

As far as columns, shaft elements, etc. are concerned which are first unloaded onto the terrain and then swivelled into vertical position using one wire winch, protect the end swivelling on the terrain using a soft underlay or corner protection when swivelling.

This also applies to stairs which are first unloaded onto the terrain and then swivelled up into the final position in the building using adapted chains.

Unless otherwise indicated, ensure that the angle of inclination of the lifting chain with level is at a maximum of 30° (min. 60° with the level).

When hoisting slab elements with four anchors, use all four anchors which means using a compensation triangle.

Carry out the unloading of elements symmetrically (in turns from side to side) to prevent skewed loading, overturning and damage to other elements. For the unloading from flats, please refer to fact sheet from [www.bar-ba.dk](http://www.bar-ba.dk).

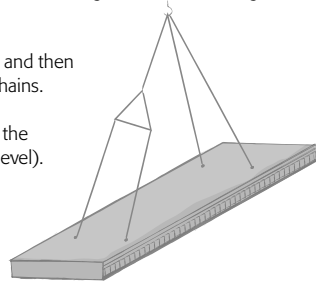

Figure: Using a compensation triangle

### BEFORE, UNDER AND AFTER INSTALLATION

Unless otherwise indicated, elements which are to be temporarily braced during installation are supplied with embedded inserts for the purpose. Their type, size and position are indicated on the element diagram.

Ensure that the tightening torque does not exceed the permissible load for the specific thread, cf. table 4.

The capacity of bracing inserts in concrete elements are set out in the table below, which also indicates the minimum bolt quality.

Bolt dimension	Insert capacity	Bolt quality	Recommended tightening torque	Equivalent load on insert
M16	16 kN	8,8	30 Nm	10 kN
M20	24 kN	6,8	55 Nm	15 kN
M24	35 kN	6,8	100 Nm	21 kN

Table 4: Tightening torque in concrete elements

Type of wall	Type of attachment	Tightening torque Nm	Calculable axial load value kN/ea.
Lightweight concrete	Expanded Super 14x70 mm pin with 12x90 mm hexagon-head screw, steel quality 4.6	30	7,0
LAC 6/1350	Insert 1140, 16x60 mm. M16 bolt in steel quality 8.8	10	6,0
LAC 10/1850 LAC 15/1850 LAC 10/2000	Insert 1140, 16x60 mm. M16 bolt in steel quality 8.8	10	7,0

Table 5: Tightening torque in lightweight concrete elements

It is possible to agree that the elements are delivered with embedded inserts for temporary railing. Type, size and position is indicated on the element diagram.

Straighten hairpins and struts using special equipment with the correct bend diameter. Elements may be delivered with temporary bracing of e.g. doors, windows and large recesses. These are to be removed by the installer after the elements have been joined and the joints have developed the required strength.

For transport purposes, the formwork at the bottom casting joint in tilting elements of a thickness of up to 120 mm has not been removed. The fitter must do so.

Cut away concrete and pipe bottom parts in doorways, etc. after the elements have been joined and the joints have developed the required strength. If bottom parts are placed above floor level in door openings, surface treat the exposed reinforcing iron to prevent the penetration of rust.

Generally, only subject the elements to full load once joined and cast together and the joints have attained the required strength.

### SPECIAL ELEMENTS

Are specified in section 5, under specific type of element.



## 5. SPECIFIC INFORMATION ABOUT THE ELEMENTS

### 5.1 COLUMNS

#### TEMPORARY STORAGE

Columns are supported at one-fifth points. Secure round columns against 'rolling'.

#### BEFORE, DURING AND AFTER INSTALLATION

Round columns are not delivered with embedded inserts for bracing. During installation, brace these columns using cross-bracing fastened in either drilled anchors or approved straps/column braces.

### 5.2 BEAMS

#### DELIVERY

Long, slim beams will often be delivered one or two at a time on a flat-bed lorry. The installation contractor must ensure that when the first beam is lifted off the remaining beam(s) is/are braced.

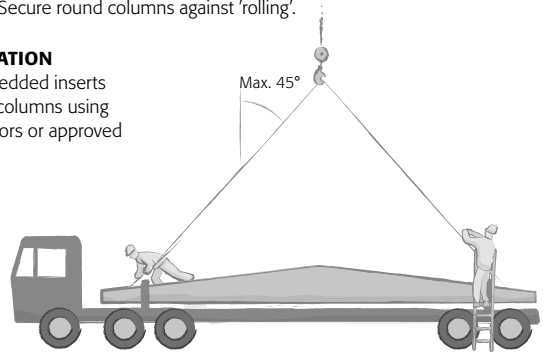

Figure: Hoisting using a lifting strap

#### HOISTING

Adjust the length of the lifting straps to ensure that the angle of inclination is at max. 45° with the vertical.

### 5.2.1 SPECIAL ELEMENTS

#### LONG OR HEAVY BEAMS

It may be necessary to cast four anchors into such beam elements. As far as possible, lifting points are positioned in the middle of the cross-section of the beams symmetrically around the longitudinal centre of gravity. This is indicated in the element diagrams.

Lift the elements using two snatch blocks which are attached to the crane hook with a two-loop chain loop or wire straps of the required length. Connect the wire anchors of the beam in pairs across the snatch block with a wire strap of the required length in a manner which ensures that no wire strap has a vertical angle of inclination exceeding 30°.

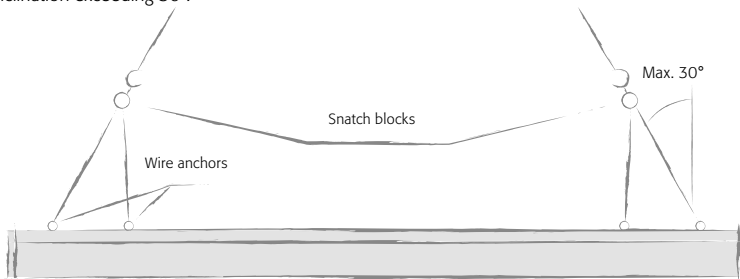

Figure: Hoisting large beams

If the beams are to be temporarily stored, store them in absolutely vertical position on a solid base. Support them under the embedded anchors. Do not stack the beams.

**ECCENTRICALLY LOADED BEAMS**

When working with eccentrically loaded beams there is a risk that, as installation progresses, the beam will tip once the load is increased. This generally applies to KB and KBE beams.

*Where this applies to other types of beams, this is indicated by OBS\_5.2.1 on the numbered plan.*

In these cases, take special precautions such as temporary support until they have been cast together and the joint has attained the required strength.

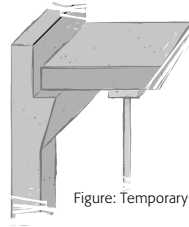

Figure: Temporary support

**5.3 WALLS AND FACADES**

**HOISTING**

As a general rule, lifting points are positioned symmetrically around the centre of gravity of the element. If this is not possible, ensure that the element is hanging horizontally by shortening the crane chains.

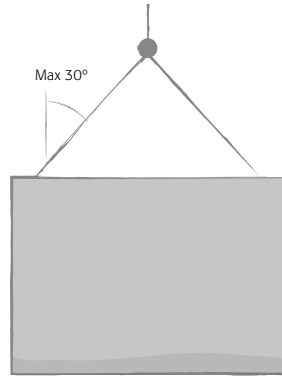

Figure: Hoisting using chains

	Lifting eyes in round bar		
	Ø mm	Colour code	Recess equivalent to
	10	Red	Gunnebo BK 10
	12	Blue	Gunnebo BK 10
	14	Green	Gunnebo BK 13
	16	Yellow	Gunnebo BK 13
20	White	Gunnebo BK 13	

Table 6: Lifting eyes in round bar

**5.3.1 ASYMMETRIC ELEMENTS WITH LARGE OPENINGS**

*Indicated with OBS\_5.3.1 on the numbered plan*

Support the element in the door opening and do not subject it to load before it is joined according to the project, unless the support is dimensioned for this load.

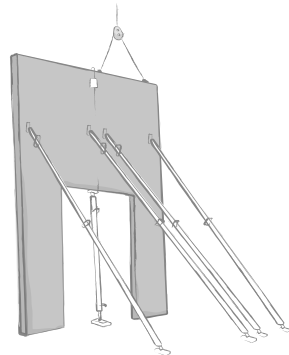

Figure: Support of asymmetrical element

### 5.3.2 TILTING ELEMENTS

When swivelling the elements using lifting eyes, use ALL embedded anchors but hoist elements with lifting systems according to the industry guidelines.

#### LIFTING EYES

Use all anchors.

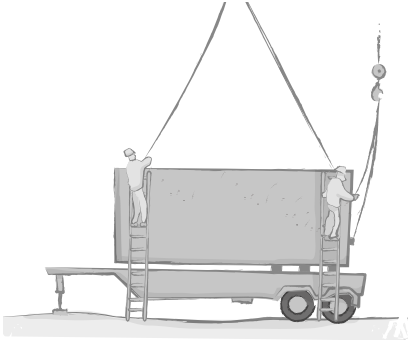

#### LIFTING SYSTEM (e.g. two-hole anchors)

Lifting instructions cf. industry guidelines.

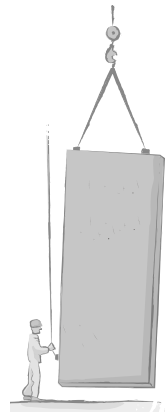
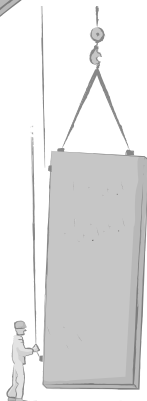
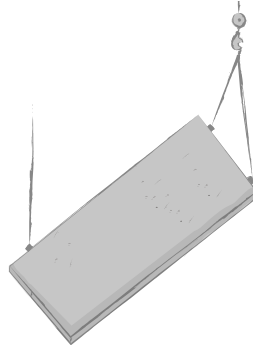
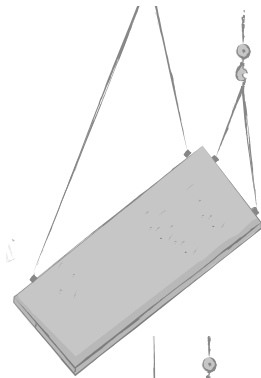
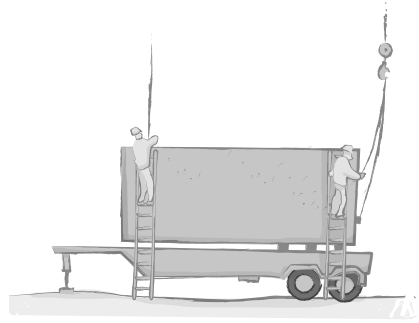

## ASYMMETRICAL ELEMENTS WITH RISK OF TIPPING

Indicated with OBS\_5.3.1 on the numbered plan

Hoist elements with large asymmetrical recesses with a risk of tipping using ALL anchors.

### LIFTING EYES

Use all anchors.

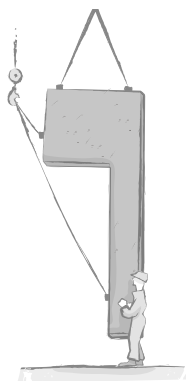
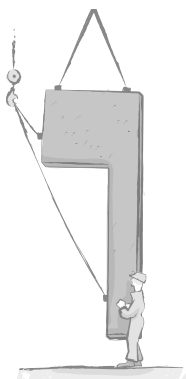
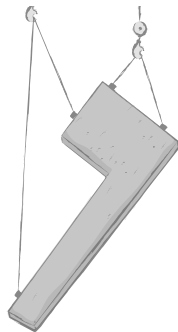
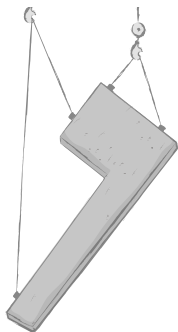
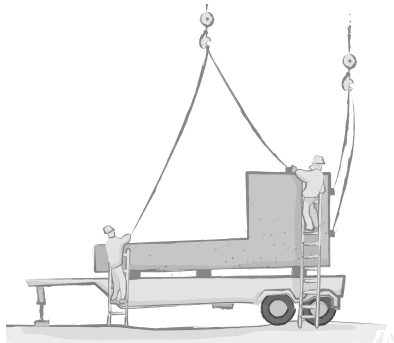
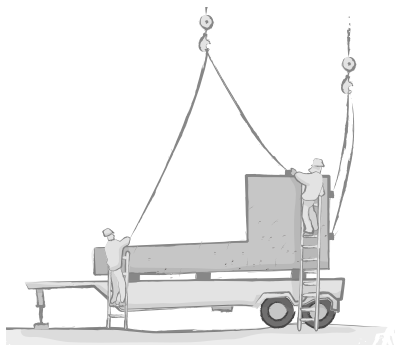

## OTHER ASYMMETRICAL ELEMENTS

Hoist asymmetrical elements as general tilting elements.

### LIFTING EYES

Use all anchors.

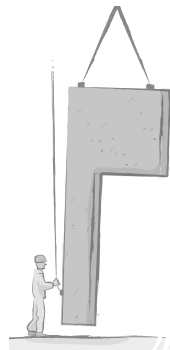
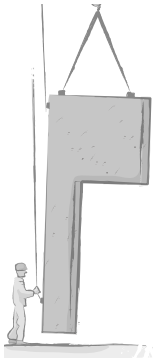
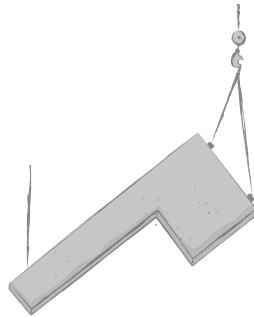
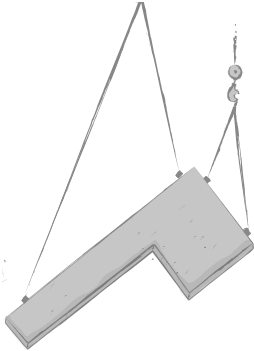
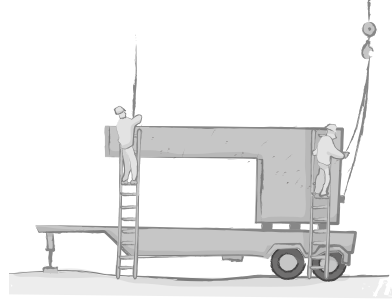
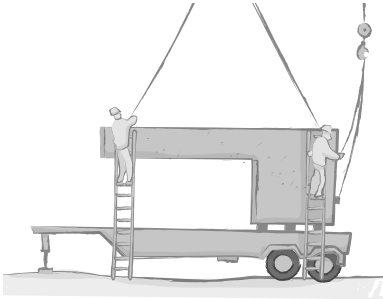

### LIFTING SYSTEM (e.g. two-hole anchors)

Lifting instructions cf. industry guidelines.

### 5.3.3 OUT-OF-PLUMB ELEMENTS

*Indicated with OBS\_5.3.1 on the numbered plan*

Elements with castings protruding from the plane face of the element may be out of plumb. The centre of gravity of elements falling within this category is outside the plane of the element.

#### HOISTING

Hoist these elements using a special yoke ensuring that the element is kept in plumb. Alternatively, by ensuring that the bottom of the element cannot slide, it may be put down while out of plumb and be pulled into place.

#### TEMPORARY STORAGE

If the element is to be temporarily stored, brace it to counteract the eccentric load.

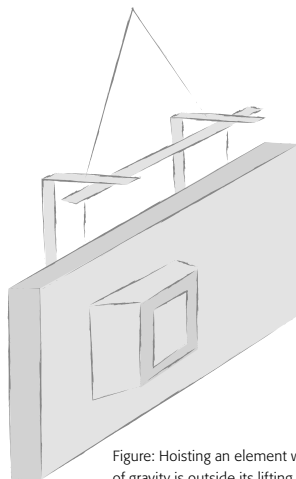

Figure: Hoisting an element whose centre of gravity is outside its lifting plane

### 5.3.4 ELEMENTS WITH WINDOW CONSOLE

Elements with window console are delivered on pallets. After delivery on site, only move these pallets using appropriate and approved lifting devices.

Pallets						
Recess	H	W	Quantity on pallet	Pallet weight between (kg/pc.)		Pallet kg/pc.
50x100	50	100	90	4,6	6,2	526
80x100	80	100	60	7,4	10,0	561
100x100	100	100	48	9,2	12,4	561
120x100	120	100	40	11,0	14,9	561
140x80	140	80	40	10,3	13,9	523
160x80	160	80	40	11,8	15,9	598

Table 7: Pallets

Do not install doors and windows directly in elements with window console.

Install doors and windows using angle brackets which are installed at the front edge of the element with window console. Fasten these angle brackets with screws or dowels which are anchored in the back wall. Fastening using angle brackets assumes that doors and windows are installed before the before brick cladding is added.

If an element with window console is placed in the bottom of a window console which is to support the window, install a supporting angle at each mullion under the element with window console.

## 5.4 FLOOR SLABS

### 5.4.1 PRE-STRESSED HOLLOW CORE SLABS TEMPORARY STORAGE

As a general rule, position lifts symmetrically around the centre of gravity of the element. If this is not possible, ensure that the element hangs horizontally by shortening the crane cables.

#### HOISTING

Pre-stressed hollow core slabs are delivered with embedded anchors for hoisting. Depending on the type and length of an element, there are four anchors 300-1000 mm from the ends and 150-500 mm from the edges of the sides.

As a standard, the elements are 1.20 m or 2.40 m wide, see element diagram.

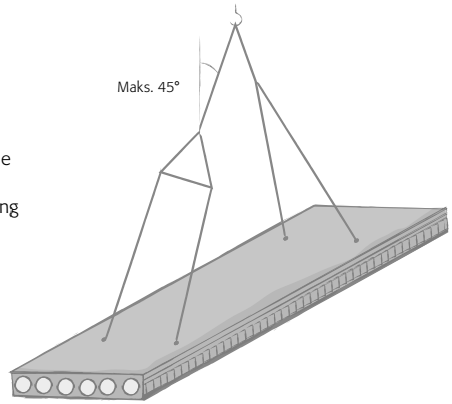

Figure: Hoisting a hollow core slab

For "special elements" of a width of less than 1.20 m and 2.40 m, respectively, sloping cuts, holes, etc. the anchors may be placed in different positions and it may be necessary to shorten chains to ensure that all anchors are used for hoisting.

In case of hollow core slabs which are shorter than 3.0 m or very narrow hollow core slabs, use down to two lifts per element.

All slabs are supplied with DEHA lifts. The angle of inclination between vertical and the loops of the chain/wire must be max 45°. See figure: Hoisting hollow core slab.

#### BEFORE, DURING AND AFTER INSTALLATION

The depth of the abutment must be min. 55 mm. For abutments on bevelled surfaces – e.g. console beams – measure the contact surface.

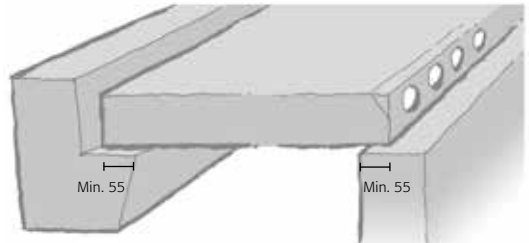

Figure: Abutment hollow core slab

Due to the risk of water retention in/frost damage to the elements, immediately after installation drill  $\varnothing 10$  mm drain holes at the abutment and in each channel. Maintain these during the entire period of construction.

#### SPECIAL ELEMENTS

##### RECESSES IN ENDS OR CANTILEVER

*Indicated with OBS\_5.3.1 on the numbered plan*

Support slabs under free corners, if there is insufficient abutment to ensure the stability of the slab until casting together.

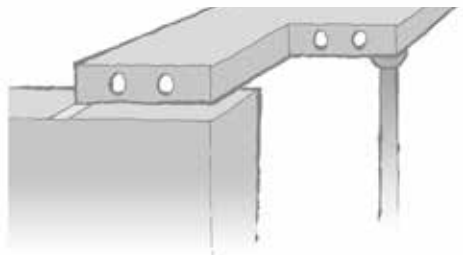

Figure:  
Temporary support of slab with large recess

##### CANTILEVER SLABS

*Indicated with OBS\_5.3.1 on the numbered plan*

Secure cantilever slabs against tipping by supporting the free end.

## SLAB WITH BEVELLED EDGE

### *Apparent from element geometry on numbered plan*

Secure slabs with bevelled edges by placing supports at all corners by chocking up the short side of the element.

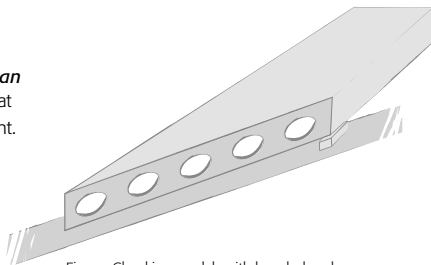

Figure: Chocking up slab with beveled end

## 5.4.2 ACOUSTIC FLOOR SLABS

### TEMPORARY STORAGE

On joists located 1/7 on the inside of each end of the slab elements. Max. 6 pcs. per stack.

### HOISTING

Usually, lifting eyes are positioned two and two facing each other 1/7 inside each end of the slab element. Small or narrow elements may have two or three embedded lifting eyes. Attach to all lifting eyes.

### SPECIAL ELEMENTS

See hollow core slab - section 5.4.1.

## 5.4.3 RIB PANELS AND PARKING SLABS

See roof panels - see section 5.5.

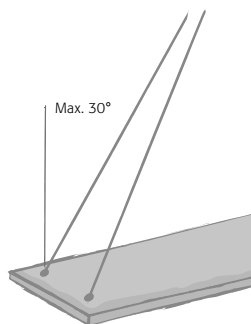

Figure: Hoisting acoustic floor slab

## 5.5 ROOF PANELS AND WAFFLE SLABS

### 5.5.1 RIB PANELS

#### TEMPORARY STORAGE

Storing RIB panels require a particularly solid base, to ensure that the RIB panels are not subjected to torsion. Place the RIB panels on top of each other using timber spacers vertically above each other underneath each rib. Place supports a max of 0.5 m from the edge of the end and stack a max of four rib panels per stack.

### HOISTING

As a standard four anchors are embedded in each element. Attach to all four anchors.

Hoist the element using a four-loop lift with compensation triangle. The angle of inclination between the element and the lifting loop must be max. 45° to vertical.

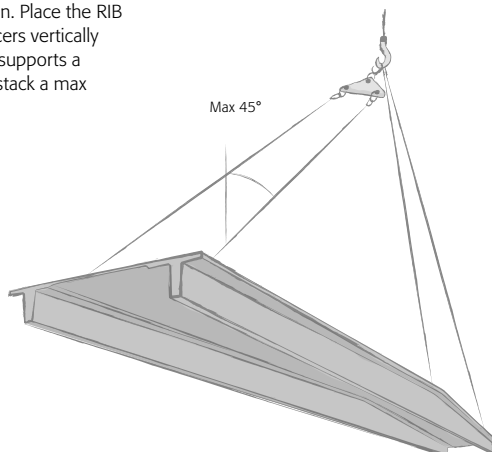

Figure: Hoisting RIB panels



## SPECIAL ELEMENTS

### ELEMENTS WITH BEVELLED ENDS / LARGE RECESSES

#### *Apparent from element geometry on numbered plan*

Elements with bevelled ends and/or large recesses do not have symmetrically positioned embedded anchors. Therefore, adjust the chain lengths using shortening claws and – as is the case with other elements – use a compensation triangle to ensure that the element is horizontal and the load is distributed between all anchors.

Due to the camber of the element, the element will rest on one RIB. Support the other RIB by adding steel shims.

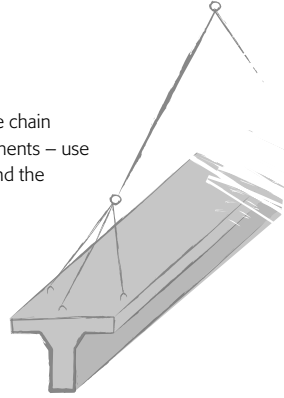

Figure: Hoisting individual ribbed roof panel

### ELEMENTS WITH ONE RIB

During storage and installation support elements with only one rib on either side of the RIB in both ends.

For elements with only one RIB and only two lifting eyes, attach as shown on the figure:  
Hoisting individual ribbed roof panel.

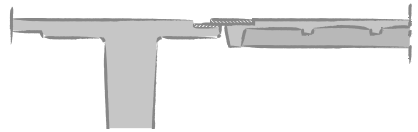

Figure: Joining TT, RTP and waffle slabs

### JOINING ROOF PANELS AND WAFFLE SLABS

Weld to be executed according to project.

### 5.5.2 WAFFLE SLABS

When installing waffle slabs, use special yoke borrowed from CRH Concrete A/S. Only use the yoke for installation of waffle slabs.

Max. five slabs = 4,000 kg incl. yoke.  
Hang the waffle slabs in the yoke one at a time, starting with the shortest chains. Fit the special lifting fittings in the chains of the yoke on the four corner fittings of the waffle slab. Make sure that the locking pawl is in place over the corner fitting of the waffle slab and that the handle of the lifting fitting turns to the central fitting of the waffle slab

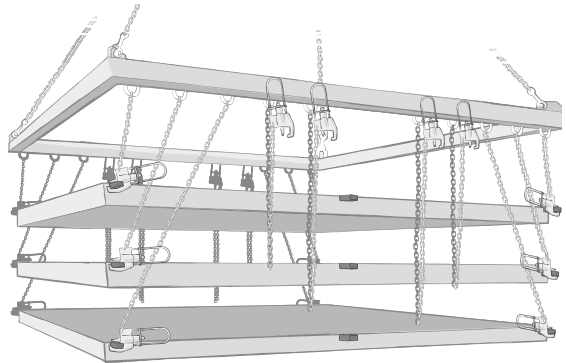

Figure: Hoisting waffle slabs

## SPECIAL ELEMENTS

### HALF WAFFLE SLABS

Only hoist two elements at a time. Hoist half waffle slabs using the standard yoke using the two middle sets of chains.

## 5.6 BALCONIES, BALCONY GANGWAYS AND STAIRS

### TEMPORARY STORAGE

Depends on element geometry and size, max. three to five in each stack.

Do not stack winding staircases.

### HOISTING

As a general rule, the elements are delivered with embedded Frimeda hoisting anchors or lifting inserts in the topside. By agreement and with consideration for limits relating to weight and geometry, stair elements may be supplied with lifting inserts embedded in the sides.

Type, dimension and position depends on the weight and geometry of the element and are stated on the element diagrams.

Position lifts as central to the centre of gravity as possible. Endeavour to position these in the one-fifth positions of the element.

As standard, there are four anchors embedded in each element. Attach to all four anchors and hoist the element using a four-loop and compensation triangle. The angle of inclination between the loop and vertical must be max. 30°.

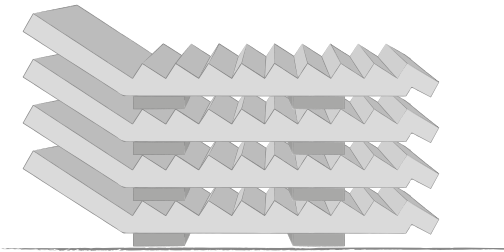

Figure: Storing stairs

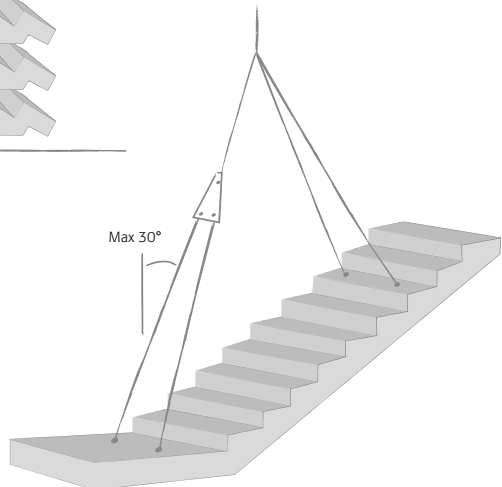

Figure: Hoisting stairway

Where lifting inserts have been positioned in the side edge of stair elements by agreement, attach using special fittings. The fittings may be borrowed from CRH Concrete, DALTON Tilst, and bolts are provided for screwing into the embedded inserts before hoisting. Bolts facing a wall are left in the elements after installation. Screw them as far into the inserts as possible after installation so as not to be too visible.

For insert/bolt dimension:

- M20 use fitting WLL 1.1 tonnes
- M24 use fitting WLL 1.5 tonnes

Max. element weight is four times WLL.

For greater element weight, up to eight times WLL, use four by two fittings with small compensation yokes.

Before tightening the chains, ensure that the bolt is slightly tightened so as to allow the fitting to turn slightly. Once the chains are just tight and before hoisting, ensure that the fitting attaches to the bolt just right, that the bolt is tight and that the bolt is locked.

Do not tighten using an electronic wrench.

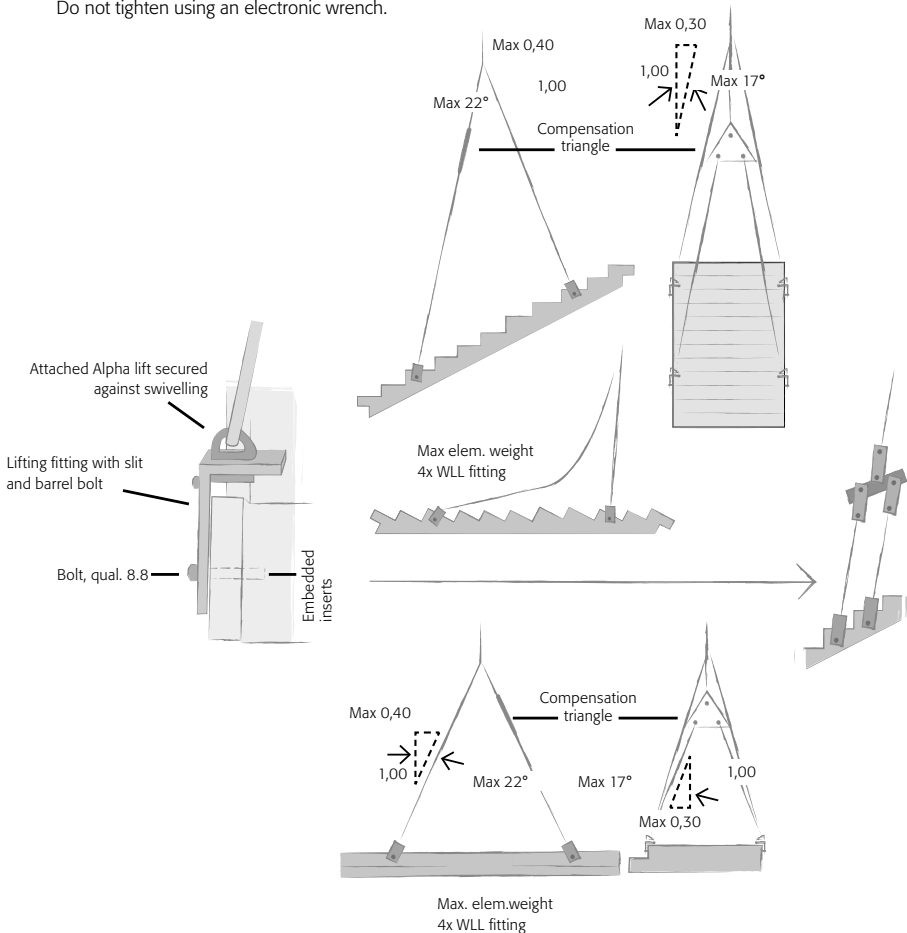

**BEFORE, DURING AND AFTER INSTALLATION**

**DOWELLED JOINTS, STAIRS**

Install dowels accurately with abutment depth as stated on the installation specifications on the elevated views/plan drawings. Check that dowels and rubber sleeves of the prescribed length, as per the drawing, are used. The length of the rubber sleeve is the inside depth and is usually 10 mm greater than the prescribed abutment depth for steel dowels plus the theoretic distance between the element edge and the wall. The rubber sleeve must fit snugly against the side edge of the stair element.

The method for installing steel dowels in the dowel sleeve (embedded steel pipe) varies depending on whether the recess in the wall is through-going or not.

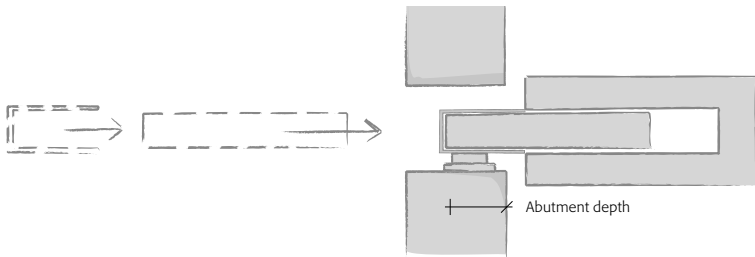

Figure: Installing dowel, through-going recess

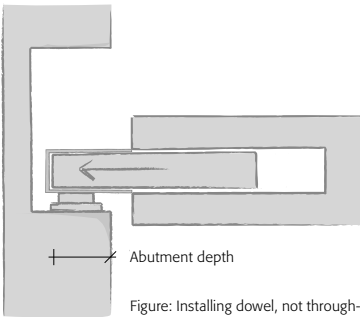

Figure: Installing dowel, not through-going recess

For through-going recesses, install the dowel and rubber sleeve from the “outside” side of the wall (neighbouring room). For not through-going recesses, install the dowel and rubber sleeve from underneath the stairs. The wall recess is sufficiently high that you can put a hand in there and pull out the dowel. Before the element is hoisted, the dowel has been pushed all the way into the dowel sleeve, so that 10 mm of the dowel protrudes from the element. Once the element is hanging slightly above the final height, pull out the dowel, push the rubber sleeve in place over the dowel and lower the element into position.

No-one is allowed on the element while it is suspended from the crane hook. For this reason, it is usually necessary to provide temporary support for the element, using e.g. steel brackets bolted to the wall. Position these with the top edge slightly below the bottom edge of the finished element and place e.g. a 25-mm board on top.

Once the element is temporarily positioned, pull out the dowel, let the fitter leave the element, hoist it slightly by crane, remove the board and then lower the element into position. The fitter can now check whether the blocking-up is adequate and, if necessary, adjust it using the procedure applied for temporary support.

## COVER TO PROTECT FROM DAMAGE AND DISCOLOURATION

Any cover applied after installation must be non-slip.

## 5.7 SHAFT ELEMENTS

### TEMPORARY STORAGE

Shaft elements may be stored horizontally on-site where the shaft elements are supported with joists in one-fifth positions. Max. two per single stack and three in double stack with through-going joists.

Do not stack round wells but secure these against rolling.

### HOISTING

Hoist/transport shaft elements in horizontal position using the one-fifth positions. Installation lift is positioned in the top of the shaft elements diagonally across the cross-section. Attach lifting fittings in the two inserts in the top of the shaft elements with suitable abutment surface to the concrete.

The angle of inclination of the lifting chain when the well is suspended vertically must be max. 15° (max. top angle of inclination 30° between the lifting chains).

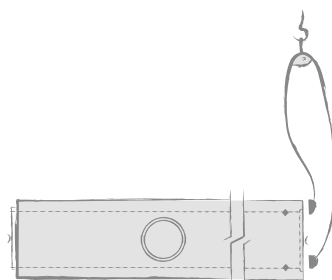

Figure: Hoisting shaft element

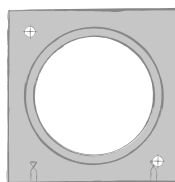

Figure: Hoisting at the top of a shaft element

## 5.8 TRIBUNE ELEMENTS

### TRIBUNE BEAMS

Handle tribune beams in the same way as large beams (see section 5.2), however, with the following added considerations.

### TEMPORARY STORAGE

Lay tribune beams on two joists that are typically positioned at the one-fifth positions of the beam. Brace the beams to a stable ground before detaching.

### HOISTING

Lift tribune beams horizontally from bed and place in temporary storage. Then shorten the chains to permit the beam to be hoisted with the inclination equivalent to the actual inclination in the construction. Alternatively, use a crane with a double winch.

### BEFORE AND DURING INSTALLATION

Brace tribune beams individually and complete and harden joints before leading the beams with tribune elements.

### TRIBUNE ELEMENT

#### TEMPORARY STORAGE

Max. five of the identical length in each stack. Position supports/spacers as close to the lifting positions as possible.

#### HOISTING

Tribune elements are supplied with four embedded lifting inserts.

Attach tribune elements by screwing in JDT swivel lift type TP in the embedded attachment inserts.



Figure: Swivel bolt



Figure: Inserts in tribune element

Attach a four-tie chain loop of suitable length and compensation triangle on the two chains to the four swivel bolts and crane hook.

## 5.9 FOUNDATIONS

### PRIOR WORKS

If no stricter requirements are specified in the documentation of the consultant, excavation and backfill must at least comply with the following requirements.

Execute the excavation to the projected depth of foundation. Perform the excavation to the solid layer of soil and level using base course gravel or a similar suitable material and compact (Std. proctor >97) and level. Finish with a minimum of 30 mm sand as fine adjustment and compact (Std. proctor >97). Finish with a thin layer of loose sand.

Performance requirements	
Height tolerance	± 20 mm
Planeness	± 10 mm/m
Inclination	± 10 mm/m

Table 8: Performance requirements for foundations

## DELIVERY

Point and straight foundations are usually delivered on a flatbed lorry.

## TEMPORARY STORAGE

Position on level and even surface.

## HOISTING

### POINT FOUNDATIONS TYPE 1

The point foundation type 1 has a mandrel hole  $\varnothing 63$  mm for a lifting mandrel in the column trunk.

For attachment to point foundations type 1, position a mandrel  $\varnothing 60$  in the two mandrel holes in the trunk. Use a two-tie chain loop of the appropriate length between the crane hook and the mandrel to ensure that the pressure of the chains on the top edge of the foundation is as light as possible.



Figure: Point foundation type 1

### POINT FOUNDATIONS TYPES 2+3

The point foundations types 2 and 3 have four embedded Frimeda anchors at the base of the column trunk.

For attachment to point foundations types 2 and 3, attach four Frimeda ring-couplings to the embedded anchors. Use a four-tie chain loop of the appropriate length between the Frimeda ring-couplings and crane hook to ensure that the pressure of the chains on the top edge of the foundation is as light as possible.

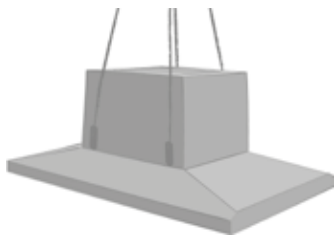

Figure: Point foundation types 2+3

Dimension and position of anchors are indicated in the construction drawings.

### STRAIGHT FOUNDATIONS

Two Frimeda anchors are embedded in the top side of straight foundations. Dimension and position of anchors are indicated in the construction drawings.

For attachment to straight foundations, attach two Frimeda ring-couplings to the embedded anchors. Use a two-tie chain loop of the appropriate length between the Frimeda ring-coupling and the crane hook to ensure that the vertical angle of inclination of the chain is max. 30°.

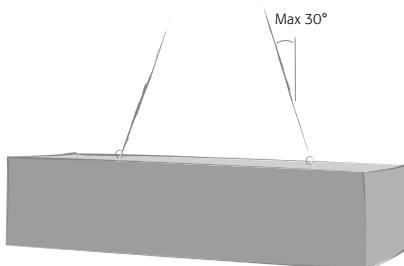

Figure: Hoisting foundation beam

## INSTALLATION

Before positioning point and straight foundations in the construction, check and ensure that the cushion on which the foundation is to be positioned has been prepared according to the requirements of the consultant in terms of construction, tolerances for planeness and levelness.

Once the point foundation is in position, check levelness and directions prior to detaching. If the point foundations have been in temporary storage before the final installation, check that the tread face of the foundation is free of soil, etc. prior to installation.

## AFTER INSTALLATION

Only add load to point and straight foundations once the required stability is present in the form of required backfilling around the foundation or other type of support.

## 5.10 PREFAB BATHROOMS

### TEMPORARY STORAGE

Position blocks according to the project. Leave sufficient space below the prefab bathroom for any protruding installations.

### HOISTING

Screw four M16 eye bolts into the four especially marked, through-going lifting bolts at the top of the delivered cubicles. One set of eye bolts M16 may be borrowed from CRH Concrete A/S (MODULBAD).

Hoist prefab bathrooms in chains with compensation triangle. Adapt the chain length according to the table below

Table for guidance			
Weight	Points of attachment		Chain Lgth.
	Max Lgth.	Max Wth.	
≤ 4,0 t	2,0 m	2,0 m	7,9 m
	2,5 m	2,0 m	8,9 m
≤ 4,5 t	2,0 m	2,0 m	8,9 m
	2,5 m	2,0 m	10,0 m
≤ 5,0 t	2,0 m	2,0 m	10,0 m
	2,5 m	2,0 m	11,1 m

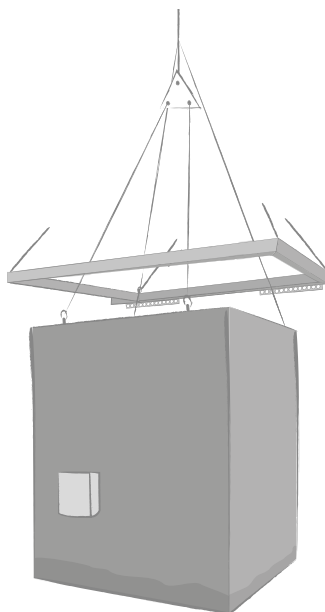

Figure: Hoisting a prefab bathroom



If this is not possible, use yokes which may be acquired from MODULBAD.

If a lifting yoke is used, comply with the following.

The lifting yoke is adjustable lengthwise by using holes at each 100 mm under the RHS bed.

The yoke is also adjustable across at every 100 mm by using the predrilled holes in the inside RHS profile. Once adjustment is complete, lock the RHS profiles together using the accompanying 16 mm lock bolt.

It is important to ensure that the short straps are vertical when hoisting within the options set out above. That is, the tolerance from plumb is 50 mm.

Attach the lifting yoke by using a chain loop/wire straps and compensation triangle. Compensation triangles are not available from CRH Concrete A/S (MODULBAD).

The weight of the cubicles are stated in the provided outline of procedures "Installing prefab bathrooms".

### **BEFORE, DURING AND AFTER INSTALLATION**

Before the cubicles are delivered to the construction site, outline and align supporting bearings of min. 80 x 80 x 10 mm on the slab where the cubicles are to be positioned. The number and position of bearings are indicated on the cubicle drawings. Adjust the height of the support by positioning plate cuttings or a similar indestructible material underneath the supporting bearings, dimension 100 x 100 x t mm.

Always ensure that the plastic foil is intact and, after installation, sealed using water-repellent tape across the four lifting bolts used. Only remove the plastic packaging around the prefab bathrooms once the construction has been roofed.

## NOTES

This issue of Supplier Instructions for use 2019  
replace the previous Supplier Instructions for use dated June 2018.  
On delivery of special elements which are not covered by these Supplier  
Instructions for use, special instructions for use will be drafted.

This Supplier Instructions for use is edited in March 2020.



[www.betonelement.dk](http://www.betonelement.dk) · [www.dalton.dk](http://www.dalton.dk) · [www.expan.dk](http://www.expan.dk) · [www.modulbad.dk](http://www.modulbad.dk) · [www.industri.build](http://www.industri.build)  
[www.crhconcrete.dk](http://www.crhconcrete.dk)